

## Sûre et performante

Rapport favorable entre hauteur, déport et surface de stabilisation utile pour la réalisation de nombreuses opérations en hauteur dans différents secteurs.

## Veilig en efficiënt

Gunstige verhouding tussen hoogte, reikwijdte en stabilisatieoppervlakte, handig voor veel soorten werk in de hoogte in verschillende sectoren.

**Capacité 230 kg** (2 personnes 80x2=160 kg + outils 70 kg)  
**Draagvermogen 230 kg** (2 personen 80x2 = 160 kg + uitrusting 70 kg)

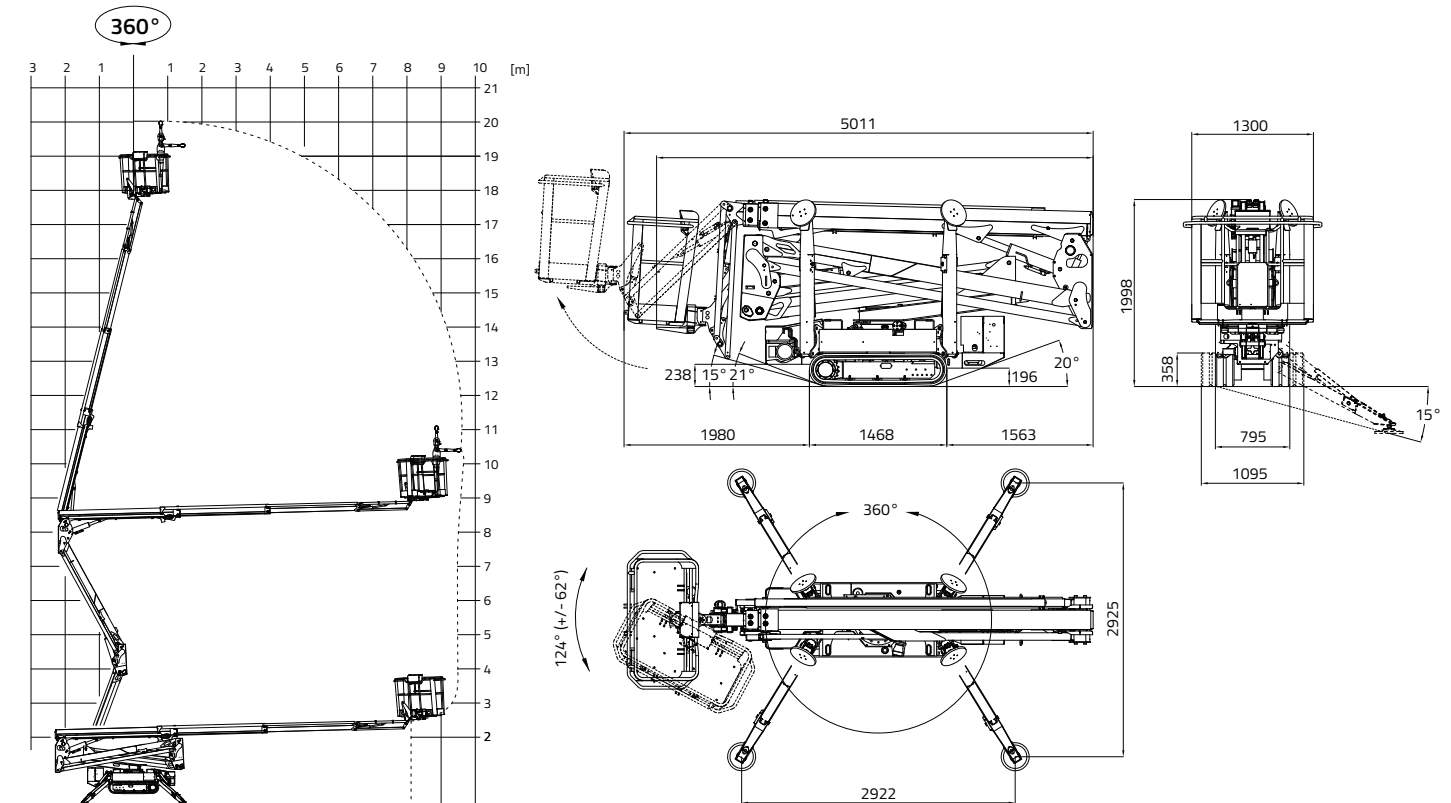

100Ah/72V  
 Optionnel - Optioneel 

 20,15 m

 9,70 m

 5,01 m

 4,39 m

 1,99 m

 1.335 x 690 x h 1.100 mm

 124° (+/-62°)

 16° / 28,7%

 2.840 kg / 6.261 lb (Honda)  
 2.940 kg / 6.481 lb (Kubota)  
 2.950 kg / 6.503 lb (Lithium-ion)

 ■ Honda iGX390 Automatic rpm control  
 11,7CV 3.600 rpm  
 ■ Kubota Z602 Autorev system 14,5CV 3.200 rpm

 2,2kW-230V-50Hz  
 2,2kW-110V-50Hz

 795 - 1.095 mm

 0,4-1,0-1,95 Km/h (Honda)  
 0,5-1,3-2,5 Km/h (Kubota)

 2.150 daN - 3,04 daN/cm<sup>2</sup>

 2.922 x 2.925 mm

 Stabilisation et destabilisation automatique  
 III S de série  
 Standaard kenmerken serie performance III S

 Télécommande  
 Afstandsbediening met kabel

 GPRS-GPS

 R.A.H.M.