



**Hinowa**<sup>®</sup>  
the future is now

# THE UNSTOPPABLE



## SOTTOCARRI CINGOLATI *TRACKED UNDERCARRIAGES*

Una gamma completa di vari modelli da 1 a 30 tonnellate di capacità di carico  
*A range consisting of various models from 1 to 30 tonnes of load capacity*

## ESPERIENZA, FORZA E AFFIDABILITÀ EXPERIENCE, STRENGTH AND RELIABILITY

I sottocarri cingolati HINOWA vengono impiegati principalmente nei settori dell'edilizia, della perforazione, nel movimento terra e in tutte le attività che richiedano mobilità in condizioni di lavoro difficili.

Il sottocarro cingolato è presente in tutta la gamma HINOWA, conferendo a macchine diverse stabilità e bassa pressione al suolo.

HINOWA spa si colloca tra i più importanti costruttori di sottocarri cingolati di piccola e media misura.

Grazie all'impiego di un sottocarro cingolato, è possibile rendere indipendente qualsiasi tipo di attrezzatura.

La componentistica impiegata possiede i migliori standard qualitativi presenti sul mercato.

I componenti maggiormente sottoposti ad usura sono sottoposti a trattamento.

Il tensionamento del cingolo avviene tramite valvola a grasso.

*HINOWA tracked undercarriages are mainly used in construction, drilling and earthmoving industries and in general all activities requiring mobility in difficult working conditions.*

*Tracked undercarriages are present in the whole HINOWA range, granting stability and low ground pressure to different machines.*

*HINOWA spa ranks among the most important manufacturers of small and midsize tracked undercarriages.*

*By using a tracked undercarriage, it is possible to make independent any type of equipment.*

*The components used are of the highest quality standards available on the market.*

*The components most subject to wear are treated.*

*The tensioning of the track is made through a grease valve.*



PT20GL



PT9



PT70



PT3000

I cingolati HINOWA possono essere forniti nelle seguenti versioni  
*HINOWA tracked undercarriages can be supplied in the following versions*



PT70G



PT70A



PT15

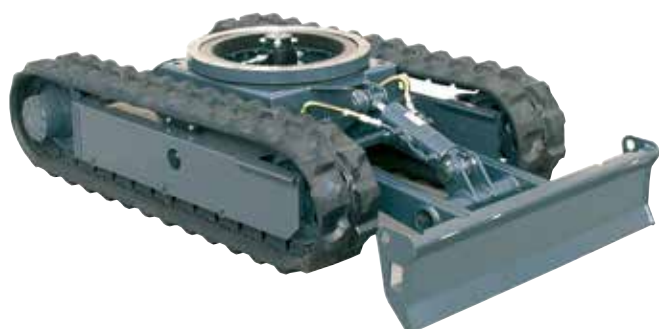

PT1350

- Cingolatura in gomma
- Cingolatura intercambiabile in gomma
- Cingolatura in acciaio
- Cingolatura in acciaio e gomma vulcanizzata
- Cingolatura in acciaio e sovrappattini in gomma
- Allargamento idraulico della cingolatura
- Carri a doppia velocità
- Motori idraulici con diverse cilindrata e riduttori con diversi rapporti
- Freni negativi multilamellari
- Supporto ralla
- Lame frontali
- Carri speciali su richiesta del cliente

- *Rubber tracks*
- *Interchangeable rubber tracks*
- *Steel tracks*
- *Steel tracks covered with vulcanized rubber*
- *Steel tracks with rubber inserts*
- *Adjustable track width*
- *Double speed tracks*
- *Hydraulic motors with various displacements and gear drives with various reduction ratios*
- *Multiplate negative brake*
- *Slew ring's support*
- *Front blades*
- *Customized undercarriages*

**Hinowa**<sup>®</sup>  
the future is now



# CINGOLATURA IN ACCIAIO

## STEEL TRACKS

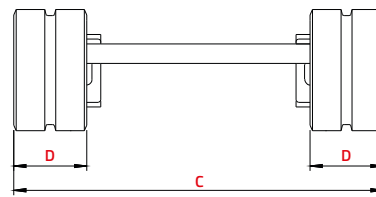
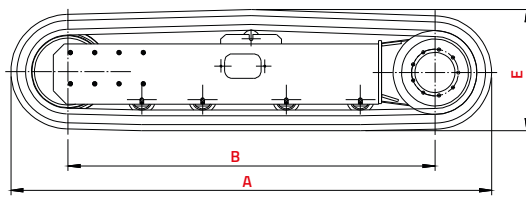

MODELLO MODEL	A	B	C	D	E	Peso limite totale (macchina + sottocarro) Max total weight (machine + undercarriage)		
						Escavatori - Dumper Excavator - Dumper	Transporter Transporter	Con stabilizzatori • With stabilizers
								Piattaforme aeree - Gru Aerial platforms - Crane
mm						kg	kg	kg
PT15A	1416	1070	980	230	370	1500	1800	2000
PT1500A	1769	1417	1100	230	380	1800	2100	2500
PT20A	1769	1390	1100	230	380	2000	2300	3000
PT20AL	1902	1552	1100	230	380	2000	2300	3000
PT2000A	1739	1328	1100	230	424	2000	2300	3000
PT2500A	1817	1370	1220	250	497	2000	3000	4000
PT3000A	1972	1509	1520	300	494	3000	4000	5000
PT3000AL	2526	2067	1520	300	494	3000	4000	5000
PT4000A	2117	1650	1660	350	490	3500	4000	5500
PT70A33	2097	1582	1700	400	550	5000	6500	9000
PT70A35	2232	1727	1700	400	550	5000	6500	9000
PT70A39	2497	1983	1700	400	550	5000	6500	9000
PT70A43	2769	2254	1700	400	550	5000	6500	9000
PT70A45	2903	2389	1700	400	550	5000	6500	9000
PT100A	3429	2707	2400	500	775	7000	10000	13000
PT100RA	2936	2360	2400	400	635	7000	10000	13000
PT150A	3235	2530	2400	500	763	10000	16000	24000

# SOTTOCARRI CON ALLARGAMENTO IDRAULICO

## TRACKED UNDERCARRIAGES WITH HYDRAULIC WIDENING SYSTEM

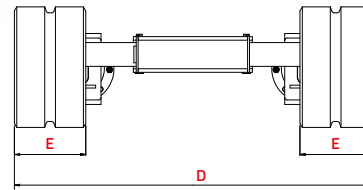
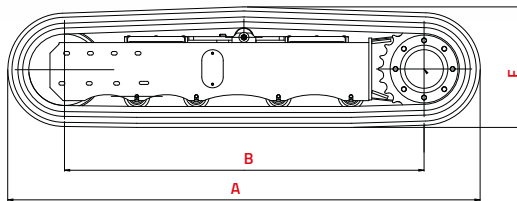

MODELLO MODEL	A	B	C	D	E	F	Peso limite totale (macchina + sottocarro) Max total weight (machine + undercarriage)		
							Con stabilizzatori • With stabilizers		
							Escavatori - Dumper Excavator - Dumper	Transporter Transporter	Piattaforme aeree - Gru Aerial platforms - Crane
mm						kg	kg	kg	
PT9CG/150	1165	865	750	1050	180	300	850	1200	1400
PT9CG/160	1165	865	700	1000	180	300	850	1200	1400
PT9CG/170	1165	865	660	960	180	300	850	1200	1400
PT9G/150	1238	937	750	1050	180	300	950	1300	1700
PT9G/160	1238	937	700	1000	180	300	950	1300	1700
PT9G/170	1238	937	660	960	180	300	950	1300	1700
PT10G/450	1210	860	670	970	200	360	1200	1400	1700
PT10G/460	1210	860	800	1100	200	360	1200	1400	1700
PT15G/450	1420	1070	700	1000	230	360	1500	1800	2000
PT15G/460	1420	1070	780	1160	230	360	1500	1800	2000
PT15G/470	1420	1070	900	1400	230	360	1500	1800	2000
PT1500G/150	1763	1407	1020	1320	230	380	1800	2000	2400
PT20G/552	1740	1390	720	1020	250	370	2000	2300	3000
PT20G/562	1740	1390	780	1200	250	370	2000	2300	3000
PT20GL/552	1935	1570	720	1020	250	370	2000	2200	3000
PT20GL/562	1935	1570	780	1200	250	370	2000	2200	3000
PT2000G/150	1728	1310	800	1200	230	430	2000	2100	3000
PT2000G/160	1728	1310	1050	1450	230	430	2000	2100	3000
PT2500G/250	1850	1370	1000	1400	250	480	2500	2800	4500
PT3000G/350	1980	1511	1000	1500	300	505	3000	3500	6000
PT3000GL/350	2534	2067	1000	1500	300	505	3000	3500	6000
PT70A33	2100	1585	1800	2400	400	550	5000	5500	9000
PT70A35	2235	1715	1800	2400	400	550	5000	5500	9000
PT70A39	2500	1950	1800	2400	400	550	5000	5500	9000
PT70A43	2775	2265	1800	2400	400	550	5000	5500	9000
PT70A45	2905	2355	1800	2400	400	550	5000	5500	9000

# CINGOLATURA IN GOMMA STANDARD E INTERCAMBIABILE CONVENTIONAL AND INTERCHANGEABLE RUBBER TRACKS

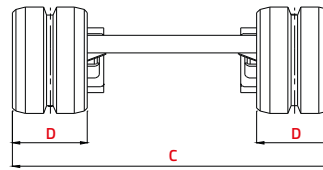
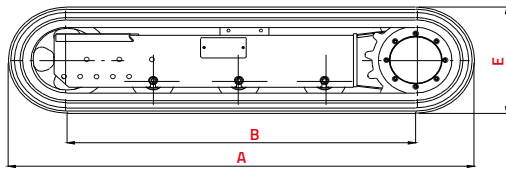

MODELLO MODEL	A	B	C	D	E	Peso limite totale (macchina + sottocarro) Max total weight (machine + undercarriage)		
						Escavatori - Dumper Excavator - Dumper	Transporter Transporter	Con stabilizzatori • With stabilizers
								Piattaforme aeree - Gru Aerial platforms - Crane
mm						kg	kg	kg
<b>CINGOLATURA IN GOMMA STANDARD • CONVENTIONAL RUBBER TRACKS</b>								
PT4G	1086	800	680	150	324	600	600	850
PT9CG	1165	865	780	180	300	850	1200	1400
PT9G	1230	930	780	180	300	950	1300	1700
PT10G	1225	860	880	200	360	1200	1400	1700
PT15G	1420	1070	980	230	360	1500	1800	2000
PT20G	1760	1390	1100	250	370	2000	2300	3000
PT20GL	1935	1570	1100	250	370	2000	2300	3000
<b>CINGOLATURA IN GOMMA INTERCAMBIABILE • INTERCHANGEABLE RUBBER TRACKS</b>								
PT10G	1235	879	880	200	370	1200	1800	2200
PT15G	1429	1070	980	230	368	1800	2100	3000
PT1500G	1765	1407	1100	230	376	1800	2100	2400
PT20G	1765	1407	1100	230	360	2000	2300	3000
PT20GL	1955	1577	1100	230	368	2000	2300	2800
PT2000G	1727	1307	1100	230	430	2000	2300	3000
PT2500G	1830	1367	1220	250	494	2500	2800	4500
PT3000G	1985	1511	1520	300	505	3000	3500	6000
PT3000GL	2541	2067	1520	300	505	3000	3500	6000
PT4000G	2111	1637	1660	350	494	3500	3500	6500
PT70G35	2210	1699	1700	400	550	5000	5500	9000
PT70G39	2499	1988	1700	400	550	5000	5500	9000
PT70G43	2790	2280	1700	400	550	5000	5500	9000
PT100RG	3000	2404	2400	450	638	7000	9000	13000

VERSIONI SEMOVENTI MOTORIZZATE  
 MOTORIZED SELF-PROPELLED VERSIONS



▲  
TS400



▲  
TS850



▲  
TS1100



▲  
TS1102



▲  
TS1103



▲  
TTX2500

Le centraline idrauliche HINOWA sono disponibili nelle seguenti versioni  
 HINOWA self-propelled units are available in the following versions

CENTRALINA HYDRAULIC UNIT	MOTORIZZAZIONI DISPONIBILI ENGINES AVAILABLE	CAPACITÀ POMPE lpm PUMPS CAPACITY lpm	PRESSIONE bar PRESSURE bar	DA MONATARE SU TO MOUNT ON
TS400	HONDA GX200	10,5	110	PT4
TS850	HONDA GX270	16	155 - 140	PT9
TS1100	HONDA GX390 - YANMAR L100N	16	155 - 140	PT9
TS1102	Kubota Z602	20	140	PT9
TS1103	Kubota D722-E3B	12	120	PT15
TTX2500	Kubota V2203	35	130	PT35

CE

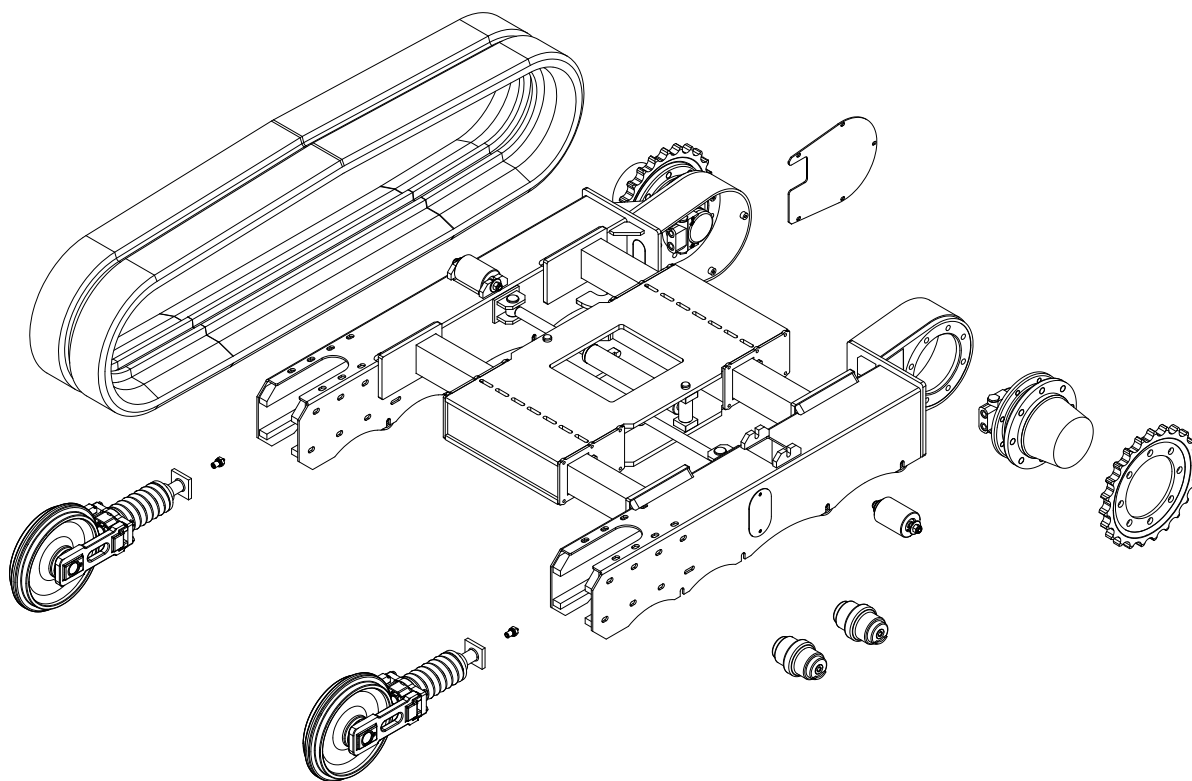

**RICAMBI ORIGINALI HINOWA ■ GENUINE HINOWA SPARE PARTS**

Per una lunga durata del sottocarro HINOWA vi raccomandiamo di usare solo ricambi originali.  
*For a long life of HINOWA undercarriages we recommend to use only genuine spare parts.*

I dati riportati sul presente catalogo sono puramente orientativi e non devono essere considerati impegnativi senza la conferma della ditta HINOWA S.p.A.  
*The specifications in this catalog are merely indicative and should not be considered binding without prior confirmation of HINOWA S.p.A. company.*

**Hinowa**<sup>®</sup>  
the future is now

HINOWA S.p.A.  
www.hinowa.com - info@hinowa.com  
Via Fontana ■ 37054 Nogara ■ Verona ■ ITALY  
Tel. +39 0442.539100 ■ Fax +39 0442.539075